

1.5sle/1.5sl/1.5s/1.5se wind turbines

English

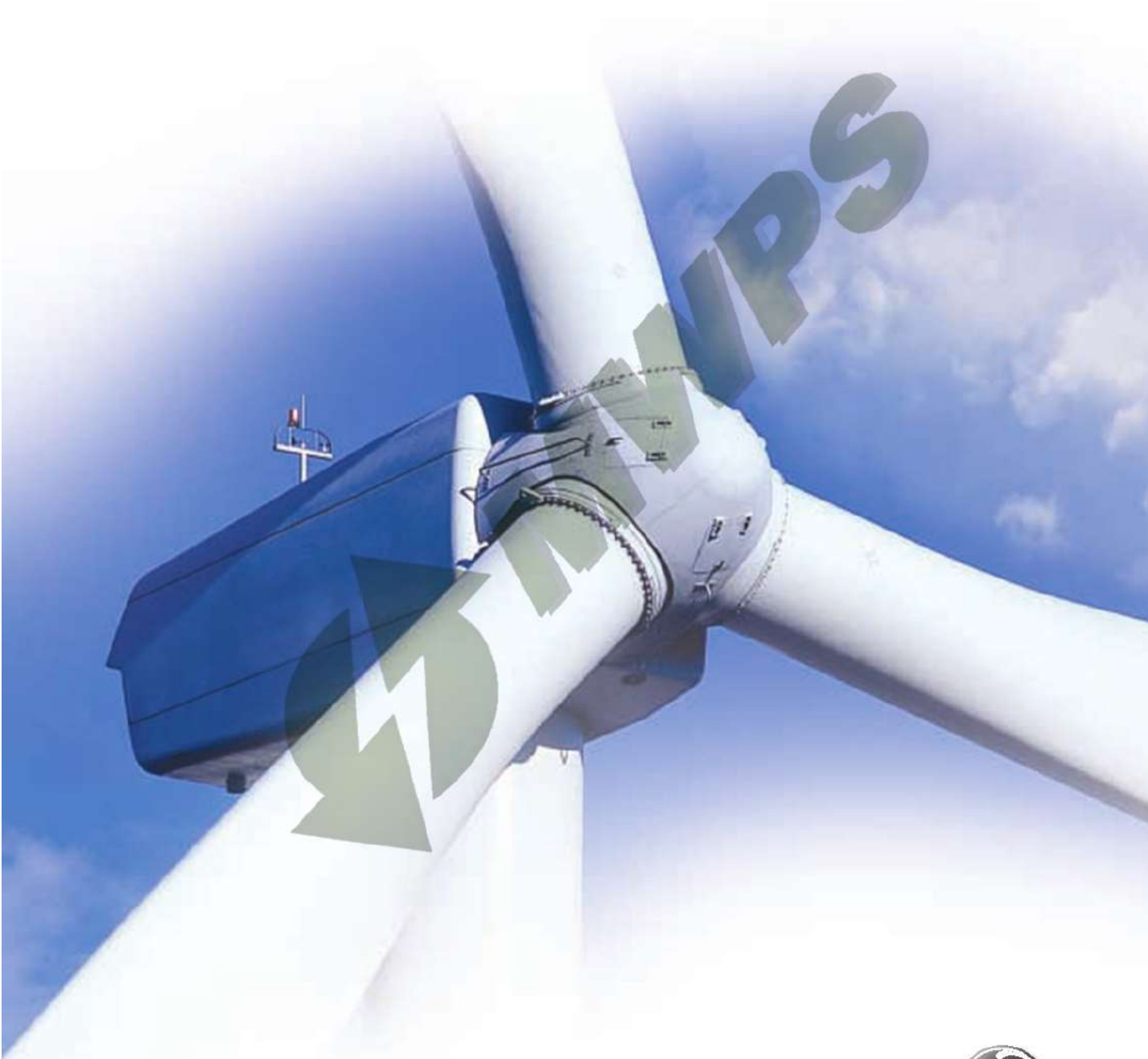

## The 1.5 MW wind turbine proven results



Fenner, USA  
20 x 1.5s  
total capacity: 30 MW



Arneburg, Germany  
20 x 1.5sl  
total capacity: 30 MW



Bassum, Germany  
13 x 1.5s  
total capacity: 19.5 MW



Gatun, Spain  
33 x 1.5sl  
total capacity: 49.5 MW

When it comes to "megawatt-plus" technology, our proven 1.5 MW wind turbine continues to raise the bar. Without resting on its past successes, our efforts to build on this proven performer include everything from technology investments in reliability and dependability, to more cost effective and versatile configurations. With over 2,300 units in operation worldwide, the 1.5 MW continues to be one of the world's most widely used wind turbines in its class.

The 1.5 MW machine is active yaw and pitch regulated with power/torque control capability and an asynchronous generator. It utilizes a bedplate drive train design where all nacelle components are joined on a common structure, providing exceptional durability. The generator and gearbox are supported by elastomeric elements to minimise noise emissions.

Slufter, the Netherlands  
8 x 1.5s,  
total capacity: 12 MW



Fenner, USA  
20 x 1.5s  
total capacity: 30 MW



Caluengo, Spain  
33 x 1.5sl  
total capacity: 49.5 MW



Slufter, the Netherlands  
8 x 1.5s  
total capacity: 12 MW

## adaptable solutions.

With variable hub heights and rotor diameters, the 1.5 MW wind turbine is both versatile and adaptable, and has proven itself in a wide variety of wind energy sites around the world, both on-land and off-shore. The 1.5 MW wind turbine features variable-speed control and independent blade pitch to assure aerodynamic efficiency and reduce loads on the drive train, yielding reduced maintenance cost overall and longer turbine life. The turbine's independent blade pitch system also mitigates the need for large emergency braking systems and enables the use of larger rotors to allow increased energy yield. At the same time, GE's unique Wind Volt-Amp-Reactive ( WindVAR ) electronics provide transmission efficiencies and enable the turbine to function harmoniously within the local grid. Reliable, cost-effective operation it was designed in from day one.

Escurillo, Spain  
33 x 1.5sl  
total capacity: 49.5 MW



# Variable Speed for higher energy capture and reduced loads.

Through the use of advanced electronics, the 1.5 MW turbine features efficient and reliable variable speed control. This feature enables the turbine's control system to continually adjust the rotor rpm level for optimum thrust at each wind speed allowing the wind turbine to continually operate at its highest level of aerodynamic efficiency. Fixed-speed wind turbines, by contrast, only attain peak efficiency at one speed.

Fenner, USA  
20 x 1.5s,  
total capacity: 30 MW

Unlike conventional variable-speed machines where all power generated is forced through the converter, the 1.5 MW design is outstandingly efficient. Through the turbine's high-efficiency converter, it is only necessary to convert a quarter of the power generated substantially minimizing conversion losses. Tower oscillation is kept to a minimum as well through active damping of the entire turbine system.

Active damping also limits peak torque, providing greater drive train reliability, reduced maintenance and longer turbine life.

Below The energy in a wind gust is stored by accelerating the rotor. This leads to reduced loads, improved transmission efficiencies and performance.

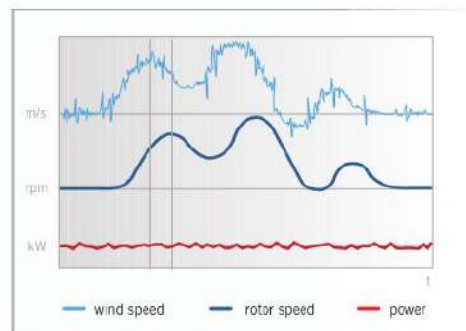
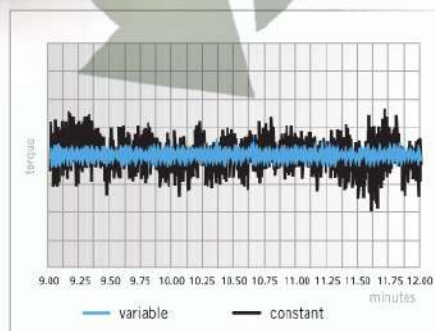

Above GE's variable speed operation provides reduced mean torque loads and smaller torque excursions for a given power output compared to constant speed wind turbines. The result is less wear on the internal drivetrain components and longer turbine life.



Escurillo, Spain  
 33 x 1.5sl,  
 total capacity: 49,5 MW

## Dynamic reactive power for transmission efficiency and local-grid compatibility.

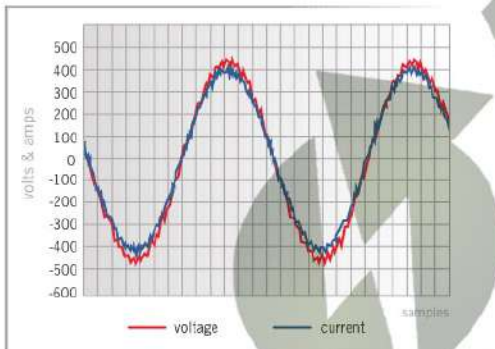

WindVAR Technology:  
 Leading, lagging or unity power factor

GE's WindVAR power conversion system with VAR control enables the wind turbines to operate at unity, leading or lagging power factor (unity power factor shown left), providing the highest transmission efficiencies and enhanced voltage stability. This is particularly beneficial in weak grid applications.



Bassum, Germany  
 12 x 1.5s,  
 total capacity: 18 MW



Heede, Germany  
 11 x 1.5s,  
 total capacity: 16.5 MW



Trent Mesa, USA  
 100 x 1.5s,  
 total capacity: 150 MW

At the heart of GE technology, our unique WindVAR power electronics system converts the wind turbine's variable-speed operation into constant-frequency power required by the utility. Through WindVAR, voltage is controlled and regulated in real-time. Similar to conventional utility generators, WindVAR enables the turbine to supply reactive power to the grid at the time it's needed, in a fraction of a second, providing transmission efficiencies and enhanced voltage stability. This feature is especially beneficial when the local grid is weak, or in larger turbine installations.

Wind speed at full height  
Standard atmospheric air  
ISO 9801-2:2001, IEC 61400-12:2007  
Standard Temperature  
Turbine air density  
at sea level

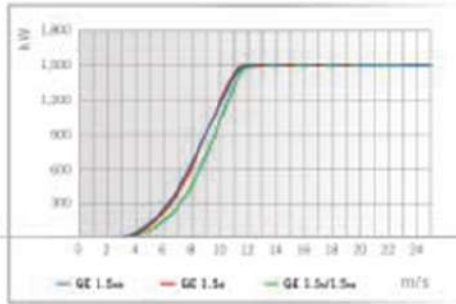

Power curve

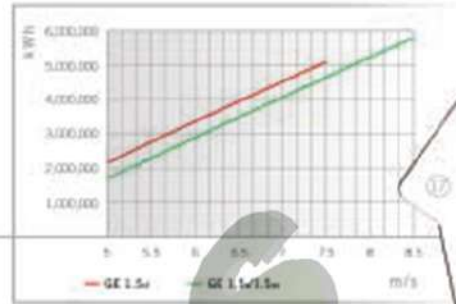

Annual energy yield

**Support services that keep your goals and expectations at the forefront.**



Trent Mesa, USA  
100 x 1.5s,  
total capacity: 150 MW



With a wide range of capabilities and proven wind project success, we can provide you with your desired level of assistance. From operation and maintenance to project development assistance we can put our experienced, worldwide resources to work for you.

Once online, your project needs are our priority. We will work with you at your preferred level of assistance then, we'll be there for you whenever you need us. Our customers are our highest priority and our goal is to deliver the absolute highest customer value when you're pleased, we are successful.

The installation and commissioning process for our turbines is rigorous. Our commissioning specialists assure that each system's operating and output patterns are optimized for each unique location.

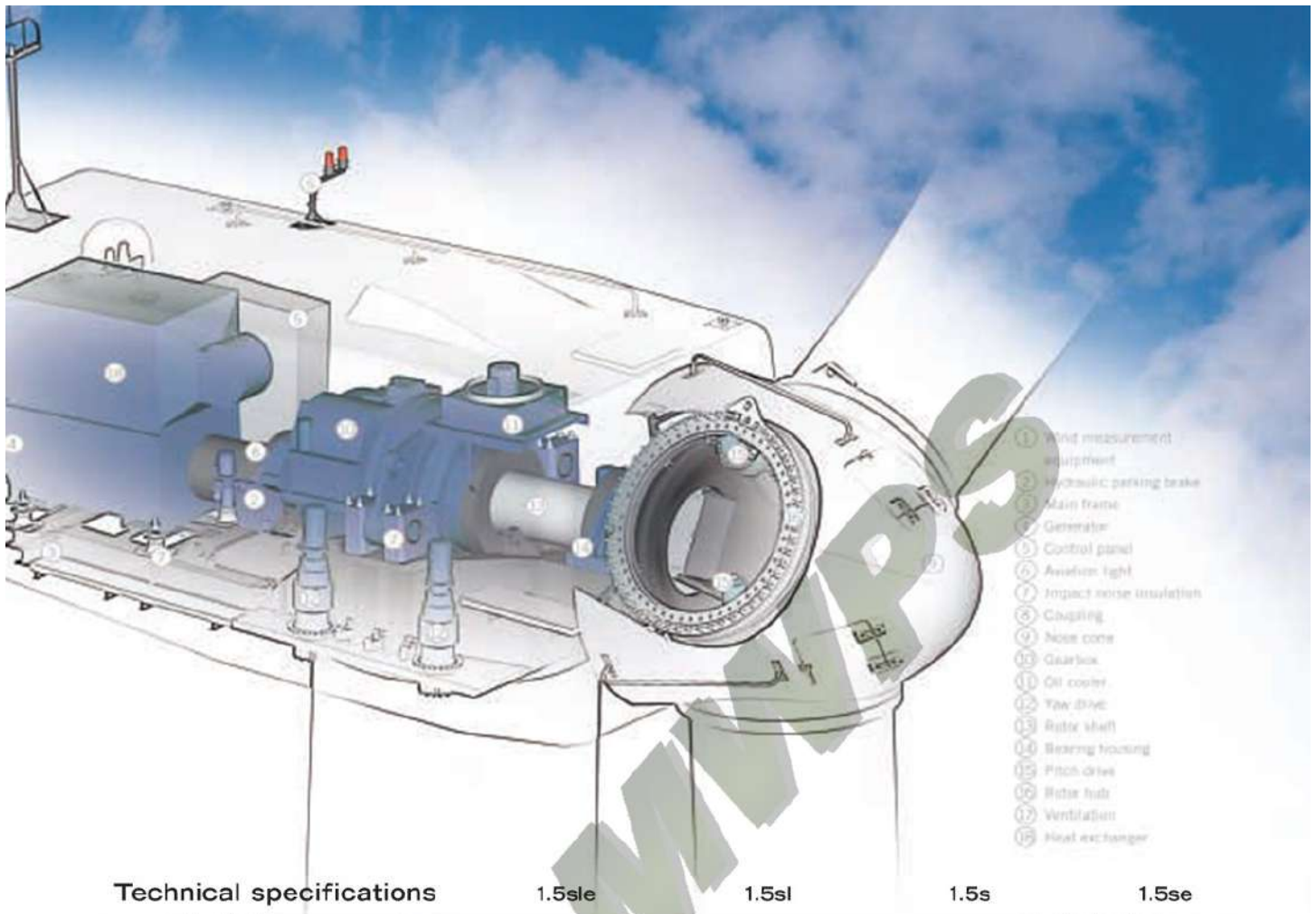

## Technical specifications

	1.5sle	1.5sl	1.5s	1.5se
<b>Operating data</b>				
Rated capacity:	1,500 kW	1,500 kW	1,500 kW	1,500 kW
Cut-in wind speed:	3.5 m/s	3.5 m/s	4 m/s	4 m/s
Cut-out wind speed				
600 s average:	25 m/s	20 m/s	WZ II: 22 m/s	25 m/s
30 s average:	IEC s: 28 m/s	WZ II: 23 m/s	WZ III, IEC II: 25 m/s	IEC I: 28 m/s
3 s average:	IEC s: 30 m/s	WZ II: 25 m/s	WZ II: 25 m/s	IEC I: 30 m/s
Cut-back-in wind speed				
300 s average:	IEC s: 22 m/s	WZ II: 17 m/s	WZ II: 19 m/s	IEC I: 22 m/s,
Rated wind speed:	12 m/s	12 m/s	WZ III, IEC II: 22 m/s	12 m/s
			12 m/s	
<b>Rotor</b>				
Number of rotor blades:	3	3	3	3
Rotor diameter:	77 m	77 m	70.5 m	70.5 m
Swept area:	4,657 m <sup>2</sup>	4,657 m <sup>2</sup>	3,904 m <sup>2</sup>	3,904 m <sup>2</sup>
Rotor speed (variable):	10.1 20.4 rpm	10.1 20.4 rpm	11.1 22.2 rpm	11.1 22.2 rpm
<b>Tower</b>				
Hub heights (m):	61.4* / 64.7* / 80* / 85*	61.4* / 64.7* / 80* / 85* / 100*	64.7** / 80** / 85** / 100*	52.6*** / 54.7*** / 64.7***
<b>Power control:</b>	Active blade pitch control	Active blade pitch control	Active blade pitch control	Active blade pitch control

**Operating limits** (outside temperature)  
 cold weather light: -20 C to +40 C  
 cold weather extreme: -30 C to +40 C /  
 -40 C to +50 C survival without operation

**Control system**  
 PLC (Programmable logic controller)  
 Remote control and monitoring system

**Gearbox**  
 Three step planetary spur gear system

**Generator**  
 Doubly fed three-phase asynchronous generator

**Braking system** (fail-safe)  
 Electromechanical pitch control  
 for each blade (3 self-contained systems)  
 Hydraulic parking brake

**Yaw system**  
 Electromechanical driven with wind  
 direction sensor and automatic  
 cable unwind

**Converter**  
 Pulse-width modulated IGBT  
 frequency converter

**Tower design**  
 Multi-coated, conical tubular steel tower  
 with safety ladder to the nacelle  
 Load lifting system, load-bearing  
 capacity over 200 kg  
 Service platform for 100 m hub height  
 (service lift optional)

**Noise reduction**  
 Impact noise insulation of the gearbox  
 and generator  
 Sound reduced gearbox  
 Noise reduced nacelle  
 Rotor blades with minimised noise level

**Lightning protection system**  
 Lightning receptors installed on blade tips  
 Surge protection in electrical components

\* for WZ II \*\* for WZ III / IEC II  
 \*\*\* for IEC I \*\* for IEC s

  Subject to technical alterations,  
 errors and omissions.



# GE Energy

GE Energy is one of the world's leading suppliers of power generation and energy delivery technology. We provide our customers with equipment, service and management solutions across the power generation, oil and gas, transmission and distribution, distributed power and energy rental industries.

As one of the world's leading wind turbine suppliers, our current product portfolio includes wind turbines with rated capacities ranging from 1,500 to 3,600 kilowatts and support services reaching from development assistance to operation and maintenance. We currently design and produce wind turbines in Germany, Spain and the U.S. In Florida, USA, we also manufacture advanced wind turbine blades to assure the highest quality, advanced designs and quick on-time delivery.

Our facilities are registered to ISO 9001:2000. Our Quality Management System, which incorporates our rigorous Six Sigma methodologies, provides you with quality assurance backed by the strength of GE. We know that wind power will be an integral part of the world energy mix in this century and we are committed to helping our customers design and implement energy solutions for their unique energy needs. Every relationship we pursue bears our uncompromising commitment to quality and innovation.

## Headquarters

Boeing Avenue 13  
1119 PC Siphof Rijk  
Amsterdam  
T (+31) (0)20 5000 111  
F (+31) (0)20 5000 199

## Asia - new markets

Sales Asia - new markets  
240 Tanjong Pagar Road, GE Tower  
058540 Singapore  
T (+65) 6326 3492  
F (+65) 6326 3522

## Denmark

Sales Scandinavia  
Niels Jernes Vej 10  
9220 Ålborg  
T (+45) 96 35 42 07  
F (+45) 96 35 42 06

## Italy

Sales Italy  
Via Felice Matteucci, 2  
50127 Florence  
T (+39) 055 423 3333  
F (+39) 055 423 2744

## Mexico

Sales Mexico  
Av. Prolongación Reforma 490-4o piso  
Col. Santa Fe, México D.F., C.P. 01210  
T (+52) (55) 5257 9523  
F (+52) (55) 5257 6182

## Germany

European Sales Headquarters  
Wind Turbine Manufacturing  
Holsterfeld 16  
48499 Salzgitter  
T (+49) (0)5971 980-0  
F (+49) (0)5971 980-1999

## Australia

Level 5, 379 Collins Street  
Melbourne, Victoria 3000  
T (+61) 3 96147444  
F (+61) 3 96147555

## France

Sales France  
Immeuble Le Bayard Part-Dieu  
3, Place Renaudel  
69003 Lyons Cedex  
T (+33) (0) 4 37 48 35 00  
F (+33) (0) 4 37 48 35 01

## Japan

Sales Japan  
Kowa 35 Building  
14-14, Akasaka 1-chome  
Minato-ku, Tokyo 107-8453  
T (+81) 3-3568-5165  
F (+81) 3-3589-3372

## Taiwan

Sales Taiwan  
168 Tun Hua North Road  
13-F Hung-Tai Center, Taipei  
T (+886) 2 2714 7040

## USA

Americas Sales Headquarters  
Wind Turbine Manufacturing  
13000 Jameson Road  
Tehachapi, CA 93561  
T (+1) 661 823 6700  
F (+1) 661 822 7880

## Canada

Sales Canada  
555 Boulevard Frederick Philipps  
3rd floor  
Montreal, Quebec, H4M 2X4  
T (+1) 905 858 5110  
F (+1) 905 858 5390

## India

Wind Turbine Assembly  
Sales India & Surroundings  
A1, Golden Enclave Corporate Towers  
Airport Road, Bangalore 560017  
T (+91) 80 2528 9979  
F (+91) 80 2520 3860

## Korea

Sales Korea  
18th, Mirae-Wa-Saram Bldg.  
942-1, Daechi-dong, Kangnam-ku  
Seoul 135-280  
T (+82) 2 528 0083  
F (+82) 2 561 0430

## United Kingdom

Sales United Kingdom  
Prince Consort House,  
27 29 Albert Embankment  
London, SE1 7TJ  
T (+44) (0)20 7793 2800  
F (+44) (0)20 7820 3401

## Spain

Wind Turbine Manufacturing  
Sales Iberian Peninsula  
María de Molina 40, 4 Planta  
28006 Madrid  
T (+34) (0)91 587 0500  
F (+34) (0)91 587 0665

## China

Sales China  
6/F West Wing, Hanwei Plaza  
No. 7 Guang Hua Road  
Chaoyang District  
Beijing 100004  
T (+8610) 6561 1166  
F (+8610) 6561 1536

## Ireland

Sales Ireland  
Clonsaugh Industrial Estate  
Clonsaugh Dublin 17  
T (+353) (0)1 803 7965  
F (+353) (0)1 803 7950

[www.gewindenergy.com](http://www.gewindenergy.com)

