

STRUCTURE DESIGN INSTRUCTION

1. SUMMARIZE

1.1 Foundation design according to following files:

(1) Extreme load for foundation design:

			Mx	My	Mxy	Mz	Fx	Fy	Fxy	Fz	Safety factor
	Load case		kNm	kNm	kNm	kNm	kN	kN	kN	kN	
Mx	Max	6.1g	18720	11940	22204	257.9	286.3	-373.3	470.4	-1042.1	1.35
Mx	Min	6.1a	-14901	2504.6	15110	-390.3	77.9	357.5	365.9	-1012.9	1.35
My	Max	6.1o	15456	27124	31218	-80.0	659.1	-344.9	743.9	-1060.4	1.35
My	Min	6.1k	-3431.6	-4315.7	5513.7	-54.9	-81.5	83.2	116.5	-1017.2	1.35
Mxy	Max	6.1o	15456	27124	31218	-80.0	659.1	-344.9	743.9	-1060.4	1.35
Mxy	Min	2.1a	-12.8	-6.8	14.5	-3.2	10.4	-5.7	11.8	-1020.9	1.1

(2) Geotechnical report of every site.

(3) 《Code for design of building foundation 》GB50007-2002

(4) 《Code for design of concrete structure 》GB50010-2002

(5) 《Code for design of high-rising structure 》GB 50135-2006

(6) Other drawing from GOLDWIND.

2. structure design summarize

structure design working life	safety classes of structure	Classifications of seismic fortification	fortification intensity
25 year	class II	category C	6

Design basic acceleration of ground motion	dynamic factor
0.05g	1.35

2. SUBGRADE AND FOUNDATION

2.1 Subgrade treat and foundation design was performed according to geotechnical investigation of the project.

2.2 Choosing natural subgrade, and subsoil bearing capacity is required over 300 KPa.

3. MATERIAL

3.1 Concrete strength grade : underlayer : C15 , principal part : C30 ;

Requirement of concrete material as following table:

Max. water-cement ratio	Min.cement consumption amount (kg/m ³)	Max.chlorion content (%)	Max.alkali content (kg/m ³)
0.65	275	0.2	3.0

3.2 Characteristic values of strength for ordinary steel bars(N/mm) shall be adapted from table below from code GB 1499. The guarantee rate for characteristic values of strength for steel bar shall not be less than 95%.

types		symbols	f _{yk}
Hot rolled steel bar	HRB335	Φ	335
	HRB400	Φ	400

4. REINFORCED CONCRETE STRUCTURE

4.1 Reinforced concrete cover of foundation is 50mm.

4.2 Connection of steel reinforcement, when the diameter of steel reinforcement is $d \geq 20\text{mm}$, mechanical connection should be adopted.

when binding lapped splice joint was used, the lenth of lapped splice and the percentage of area for lapped splice joint in steel reinforcement should obey corresponding requirement of 《Code for acceptance of constructinal quality of concrete structures 》GB 50204-2002.

4.3 The check and accept of steel reinforcement should be performed by code GB50204 after arrangement and binding.

NAME	GOLDWIND TYPE S50/750 TOWER 50m IEC 11A
	STRUCTURE DESIGN INSTRUCTION
EDITION	1
CATEGORY	CONCRETE STRUCTURE
NO.	01

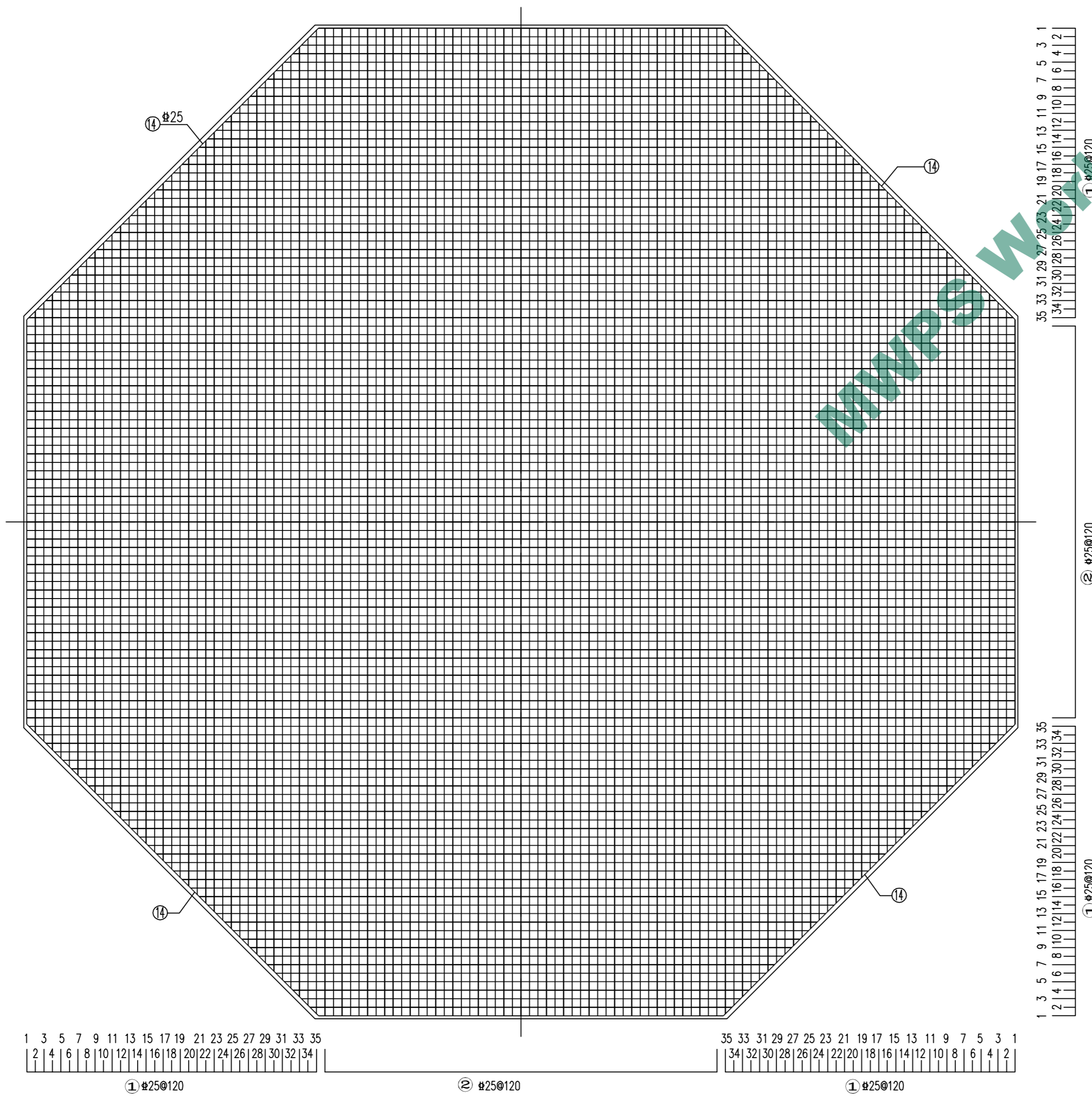

BOTTOM REINFORCEMENT

NAME	GOLDWIND TYPE S50/750 TOWER 50m IEC 11A
	STRUCTURE DESIGN INSTRUCTION
EDITION	1
CATEGORY	BOTTOM REINFORCEMENT
NO.	03

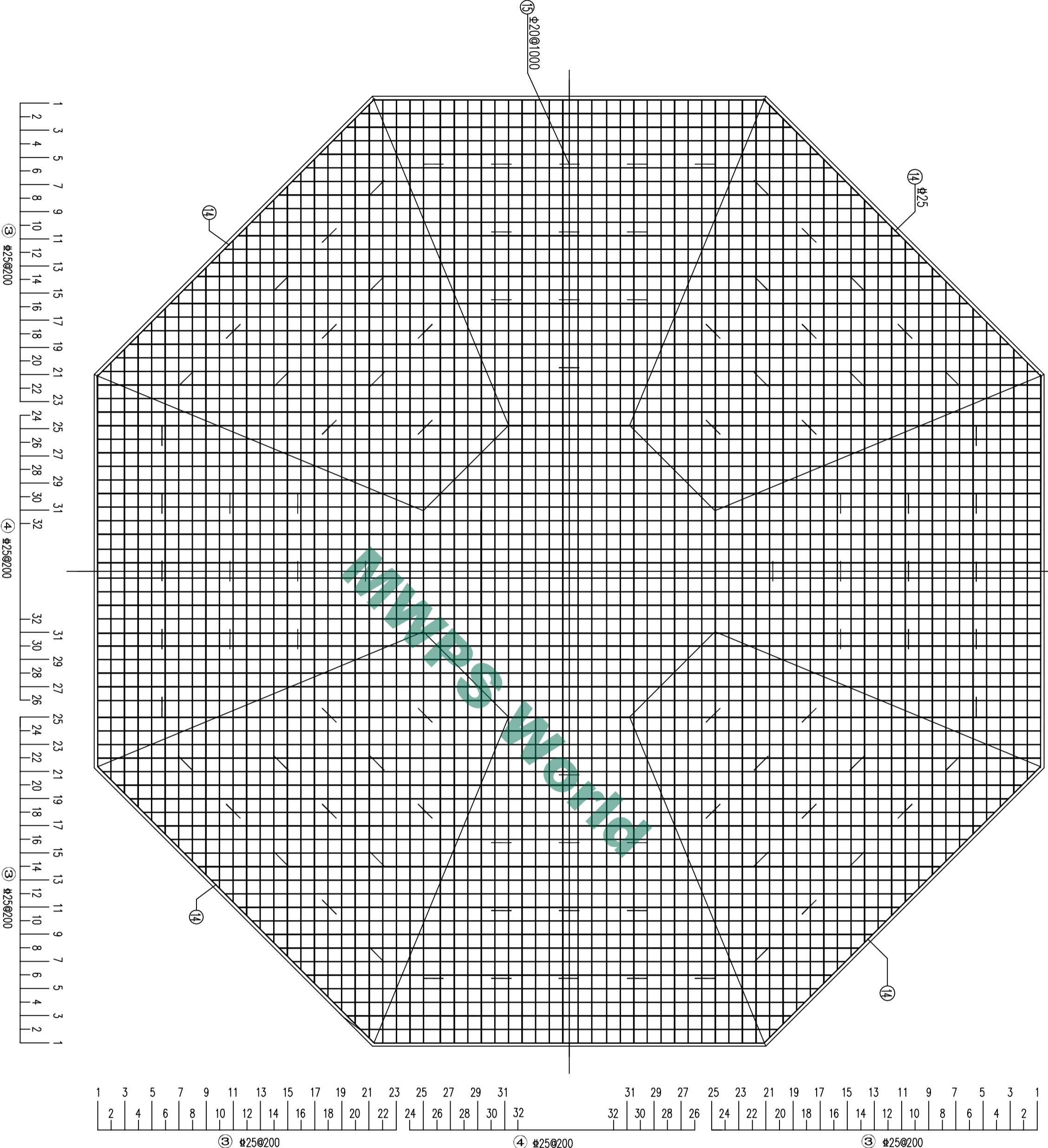

TOP REINFORCEMENT

NAME	GOLDMIND TYPE S50/750 TOWER 50m IEG 11A
STRUCTURE DESIGN INSTRUCTION	
EDITION	1
CATEGORY	TOP REINFORCEMENT
NO.	04

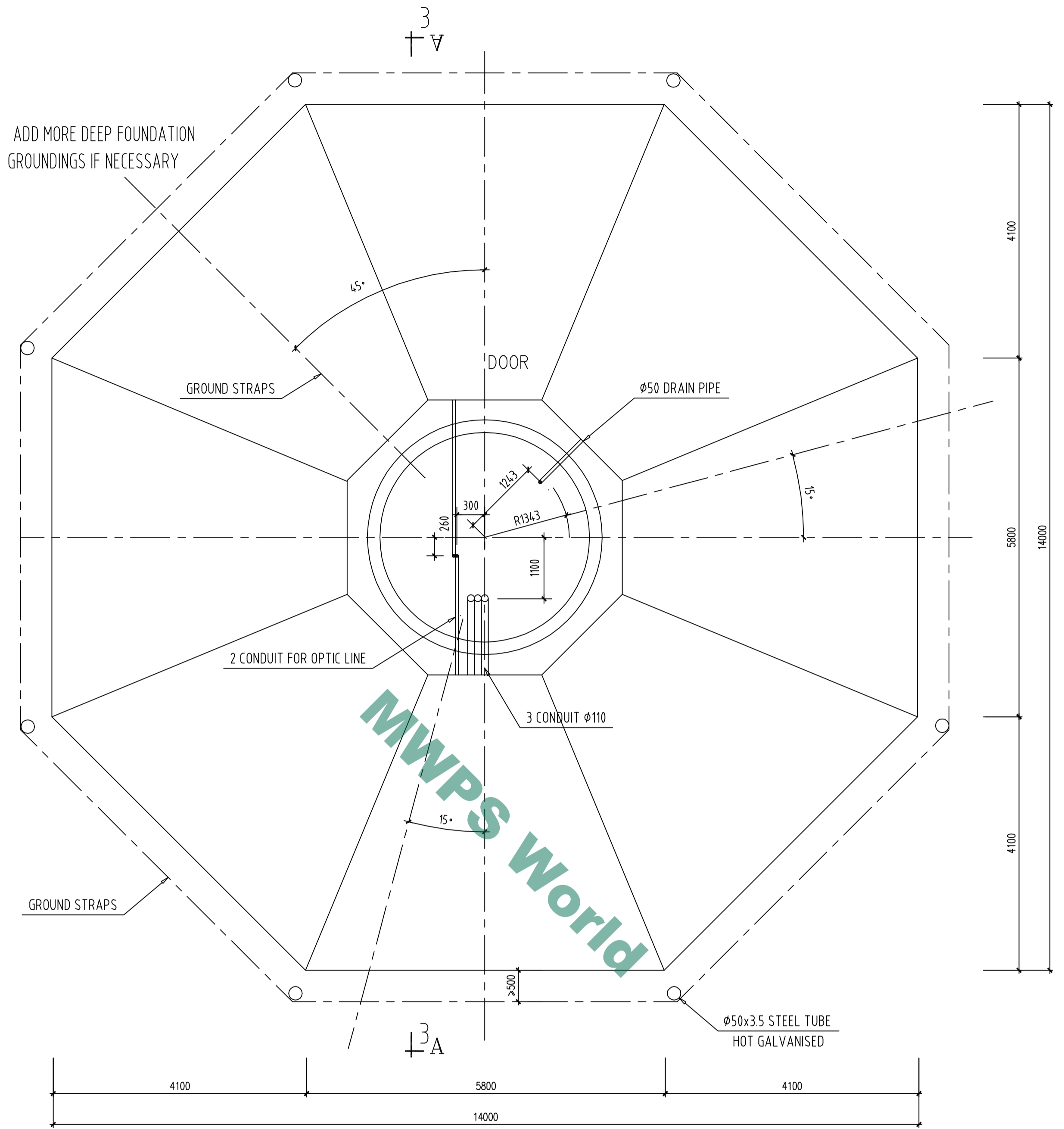



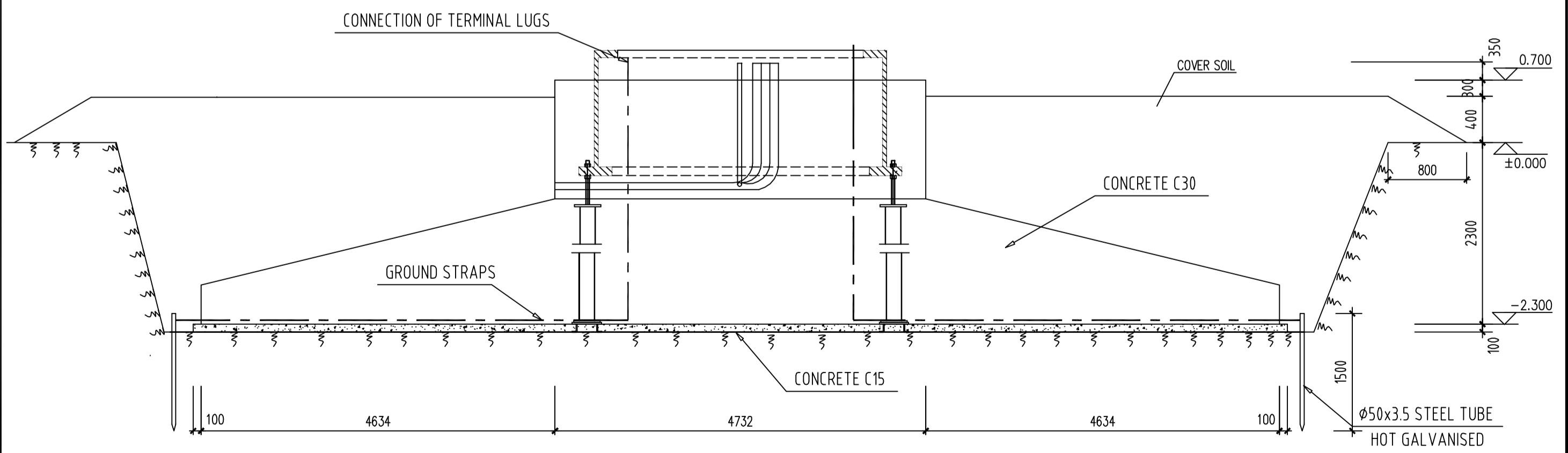





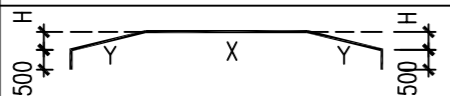
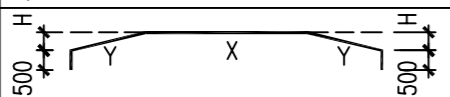
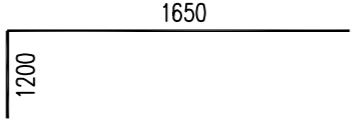
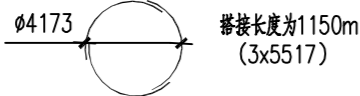
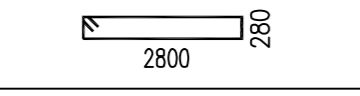

MWPS World



3-3

NAME	GOLDWIND TYPE S50/750 TOWER 50m IEC 11A
	STRUCTURE DESIGN INSTRUCTION
EDITION	1
CATEGORY	REINFORCEMENT ARRANGEMENT
NO.	05

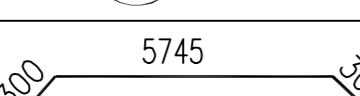
STEEL SCHEDULE

NO.	SHAPE	DIAMETER	COUNT	LENGTH	NOMINAL WEIGHT (Kg/m)	OVERALL WEIGHT (Kg)
①	X	Φ25	140	SEE BARS IN 1 LAYER	3.850	5274.1
②	13900	Φ25	94	13900	3.850	5030.4
③		Φ25	100	SEE BARS IN 1 LAYER	3.850	4428
④		Φ25	40	SEE BARS IN 1 LAYER	3.850	2330
⑤		Φ20	48	2850	2.466	337.3
⑥		Φ16	3	16553	1.578	78
⑦		Φ20	116	6560	2.466	1876.5
⑧		Φ16	58	5080	1.578	465
⑨		Φ16	2	14907	1.578	47
⑩		Φ16	2	11950	1.578	38
⑪		Φ16	3	10407	1.578	49
⑫		Φ20	16	6730	2.466	265.5
⑬		Φ16	1	6900	1.578	10.9
⑭		Φ25	4	6345	3.850	97.7
⑮		Φ20	8	1245	2.466	598.9
			24	1030		
			24	815		
			40	600		
⑯		Φ20	48	3000	2.466	355.1
OVERALL WEIGHT OF STEEL BARS						21379

BARS IN 1 LAYER

①	编号	X(mm)	编号	X(mm)	编号	X(mm)
	1	5705	15	9065	29	12425
	2	5945	16	9305	30	12665
	3	6185	17	9545	31	12905
	4	6425	18	9785	32	13145
	5	6665	19	10025	33	13385
	6	6905	20	10265	34	13625
	7	7145	21	10505	35	13865
	8	7385	22	10745		
	9	7625	23	10985		
	10	7865	24	11225		
	11	8105	25	11465		
	12	8345	26	11705		
	13	8585	27	11945		
	14	8825	28	12185		

③	编号	X(mm)	Y(mm)	H(mm)
	1	5757	71	10
	2	5591	287	50
	3	5425	573	89
	4	5259	858	129
	5	5093	1144	168
	6	4927	1429	208
	7	4761	1715	248
	8	4595	2000	287
	9	4429	2286	327
	10	4263	2571	366
	11	4097	2857	406
	12	3931	3143	446
	13	3765	3428	485
	14	3599	3714	525
	15	3433	3999	564
	16	3267	4285	604
	17	3101	4570	644
	18	2935	4856	683
	19	2769	5141	723
	20	2603	5427	762
	21	2437	5713	802
	22	2271	5921	842
	23	2105	6009	881
	24	1939	6097	921
	25	1773	6184	960

④	编号	X(mm)	Y(mm)	H(mm)
	26	2181	5986	990
	27	2581	5740	990
	28	2981	5543	990
	29	3381	5346	990
	30	3781	5149	990
	31	4181	4953	990
	32	4300	4944	990

NO.	ITEM	UNIT	COUNT
1	EXCAVATING	m³	614.1
2	UNDERLAYER CONCRETE	m³	16.71
3	PRINCIPAL CONCRETE	m³	202.02
4	STEEL BARS	t	21.379

NAME	GOLDWIND TYPE S50/750 TOWER 50m IEC 11A
STRUCTURE DESIGN INSTRUCTION	
EDITION	1
CATEGORY	STEEL SCHEDULE
NO.	06